

2.2.3 Juno+ USB Interface

Convert your laptop or desktop PC into an Ophir sensor power/energy meter

- From sensor to interface to PC - powered from USB
- Autonomous mode: Outputs voltage relative to measurement while connected via USB to a standalone power supply and not a PC
- Plug and play with all standard Ophir smart sensors
- Position & size measurement with BeamTrack sensors
- Record every energy pulse at up to 10kHz
- Analog output
- Log power and energy, average, statistics, histograms and more with included StarLab application
- Pulsed Power measurements with Thermopile detectors
- Low Frequency Power - power measurement from pulse cycle energy (for VCSEL)
- LabVIEW VIs and COM Object interface



Smart Sensor to Juno+ to PC

Ophir's basic smart compact Juno+ module turns your PC or laptop into a full-fledged Ophir laser power/energy meter. Just install the software, plug the sensor into the Juno+

module and connect the Juno+ with a standard USB cable to the PC USB port. You can connect several Juno+ modules to the PC.

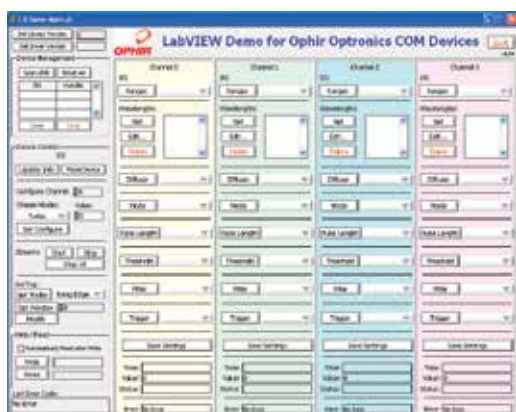

LabVIEW

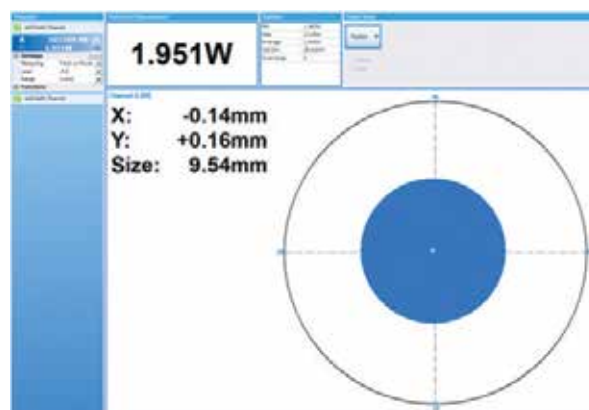

Juno+ with BeamTrack sensor and StarLab showing beam power, position and size

Specifications

Power Measurement	
Power log period	1s to Unlimited
Energy Measurement	
Max logging rate	10,000Hz ^(a)
Trigger input and output	N.A.
Timing	Supports time stamp for each pulse - resolution 1μs
General	
Number of sensors supported	One sensor per unit. Can combine several units with software for display of up to 8 sensors on one PC
Compatible sensors	Supports all standard Ophir Pyroelectric (PE-C series), Thermal, BeamTrack and Photodiode sensors. Works with our PD300RM sensors.
Power supply	Powered from USB
Outputs	USB and user selectable 1, 2, 5 and 10 Volt full scale analog output
Dimensions	105mm L x 80mm W x 29mm H
Weight	0.164 kg
Compliance	CE, UKCA, China RoHS
Note:	(a) This is the data logging rate for every single point in turbo mode. Above that rate, the instrument will sample points but not log every single point

Ordering Information

Item	Description	Ophir P/N
Juno+	Module to operate one Ophir sensor from your PC USB port. Comes with software	7Z01252
Juno+ USB cable	USB-A to MINI-B Cable (1 unit supplied with Juno+)	7E01217
Standard Analog Output Connector	2.5mm mono jack (1 unit supplied with Juno+)	7E02008

2.2 PC Interfaces

2.2.1 PC Connectivity Options for Power/Energy Measurement

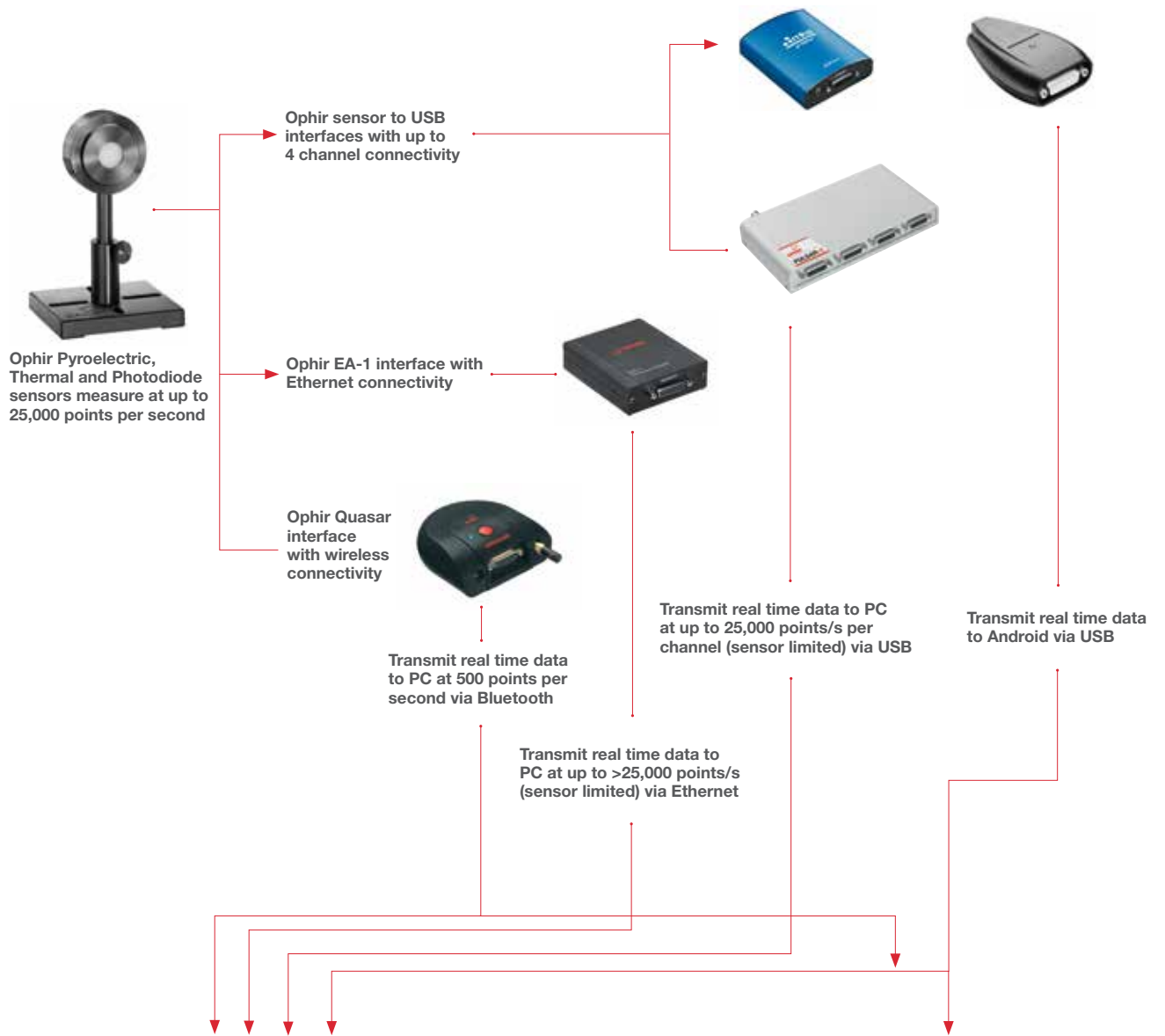

StarLab Software (data transmitted via USB, Ethernet or Bluetooth)



StarLab Software

StarViewer Application (data transmitted via Bluetooth and USB)



StarViewer Android Application

2.2.8 Summary of Computer Options for Ophir Meters and Interfaces

Communications

With Ophir RS232, Bluetooth, USB and Ethernet communication options you can transfer data from the sensor to the computer in real time or offline. You can also control your Ophir power meter from the computer.

- USB on Nova II, Vega, StarBright, Centauri (optional on StarLite) power meters and Juno, Juno+, Pulsar PC interfaces
- Bluetooth wireless on Quasar interface
- RS232 on Nova II, Vega, StarBright, Centauri and Juno-RS optional on Nova
- Ethernet on EA-1 interface and Centauri power meter

Ophir Power Meter and Interface Specifications

Model	Centauri	StarBright	Nova II / Vega	StarLite	Nova	Juno / Juno+	Juno-RS	Pulsar-1, 2 or 4	EA-1	Quasar Bluetooth	
Communication method	USB / RS232 / Ethernet	USB / RS232	USB / RS232	USB ^(c)	RS232	USB	RS232	USB	Ethernet	Bluetooth	
Power Measurement											
Power log period	1s to 1000hr.	1s to 1000hr.	12s to 600hr.	N.A	5s to 24hr.	1s to Unlimited	1s to Unlimited	1s to Unlimited	1s to Unlimited	1s to Unlimited	
Max points stored onboard	Unlimited	Unlimited	Nova II 5400 Vega 27000	N.A	300	N.A	N.A	N.A	N.A	N.A	
Max points direct on PC	Unlimited	Unlimited	Unlimited	N.A	Unlimited	Unlimited	Unlimited	Unlimited	Unlimited	Unlimited	
Analog output	1V, 2V, 5V, 10V F.S.	1V, 2V, 5V, 10V F.S.	1V, 2V, 5V, 10V F.S.	1V F.S.	1V F.S.	N.A / 1V, 2V, 5V, 10V F.S.	1V, 2V, 5V, 10V	N.A	N.A	N.A	
Energy Measurement											
Max logging rate	25,000Hz USB 30Hz RS232	5000Hz USB 30Hz RS232	>2000Hz USB ^(a) >30Hz RS232	20Hz ^(c)	>10Hz	10,000Hz ^(a)	500Hz ^(a)	25,000Hz ^(a)	>25,000Hz ^(a)	500Hz	
Max onboard data logging rate	25,000Hz	5000Hz	4000Hz ^(a)	N.A	>10Hz	N.A	N.A	N.A	N.A	N.A	
Max points stored USB/onboard	Unlimited	Unlimited	Nova II 59,400 Vega 250,000	N.A	1000	N.A	N.A	N.A	N.A	N.A	
Trigger input and output	Trigger input to synchronize measurement of pulses	N.A	N.A	N.A	N.A	N.A	N.A	BNC trigger input to enable measurement of missing pulses. Can also be configured to give trigger output	N.A	N.A	
Timing - time stamp for each pulse	resolution 1µs	resolution 1µs	N.A	N.A	N.A	resolution 1µs	resolution 1µs	resolution 1µs	resolution 1µs	resolution 10ms	
General											
Com Object	yes	yes	yes	yes ^(c)	no	yes	no	yes	yes	no	
LabVIEW VIs	yes	yes	yes	yes ^(c)	yes	yes	no	yes	no	no	
Maximum baud rate	115200	115200	38400	N.A	19200 ^(b)	N.A.	115200	N.A.	N.A.	N.A.	
PC file format	Text files, spreadsheet compatible ASCII										
TTL Out	yes	N.A	N.A	N.A	N.A	N.A	N.A	N.A	N.A	N.A	
Number of sensors supported	2 / 1 sensors per unit. Can combine several units with software for display of up to 8 sensors on one PC	One sensor per unit. Can combine several units with software for display of up to 8 sensors on one PC	One sensor per unit. Can combine several units with software for display of up to 8 sensors on one PC	One sensor per unit. Can combine several units with software for display of up to 8 sensors on one PC	One sensor per unit. Can combine several units with software for display of up to 8 sensors on one PC	One sensor per unit	One sensor per unit. Can combine several units with software for display of up to 8 sensors on one PC	One sensor per unit	4 / 2 / 1 sensors per unit. Can combine several units with software for display of up to 8 sensors on one PC	One sensor per unit. Can combine several units with software for display of up to 8 sensors on one PC	One sensor per unit. Can combine several units with software for display of up to 7 Quasars on one PC
Compatible sensors	Supports most Ophir pyroelectric, thermal and photodiode sensors										
Power supply	Powered from internal rechargeable battery power supply	Powered from internal rechargeable battery power supply	Powered from internal rechargeable battery power supply	Powered from internal rechargeable battery power supply	Powered from internal rechargeable battery power supply	Powered from USB	12V wall cube plugs into jack on rear	12V wall cube plugs into jack on rear	12V wall cube plugs into jack or PoE	Powered from internal rechargeable battery power supply	
Dimensions	47 x 200 x 130mm	212 x 114 x 40mm	208 x 110 x 43mm / 210 x 109 x 36mm	211 x 114 x 40mm	205 x 95 x 39mm	77 x 55 x 23mm / 105 x 80 x 29mm	114 x 80 x 29mm	103 x 190 x 33mm	93 x 73 x 29mm	94 x 96 x 36mm	

Notes: (a) The above refers to the rate for logging every single point in turbo mode. Above that rate, the instrument will sample points but not log every single point.
 (b) For pyroelectric sensors, maximum guaranteed baud rate is 9600.
 (c) StarLite must be USB enabled in order to work with StarLab. If your StarLite has not been USB enabled, please contact your Ophir distributor in order to obtain a USB Activation Code. Now available: StarLite with USB enabled (P/N 7Z01569)

2.3 Software Solutions

2.3.1 StarLab

StarLab turns your PC into a laser power/energy multi-channel station

Extensive Graphic Display of Data

- Line Plot, Histogram, Bar chart, Simulated Analog Needle
- Multiple data sets on one graph or separate graphs on the same screen

Advanced Measurement Processing

- Power/Energy Density, Scale Factor, Normalize against a reference
- Multi-channel comparisons
- User defined mathematical equations: channels A/B, (A-B)/C etc.
- Position & size measurement with BeamTrack sensors

Data Logging for Future Review

- Can be displayed graphically or saved in text format
- Easily exported to an Excel spreadsheet

Fully supports IPM, Ariel, Centauri, StarBright, StarLite, Vega, Nova II, Pulsar, Juno, Juno+, Juno-RS, Quasar and EA-1 devices with all standard Ophir sensors

Flexible Display Options with StarLab

Choose which channels to display



Setup screen

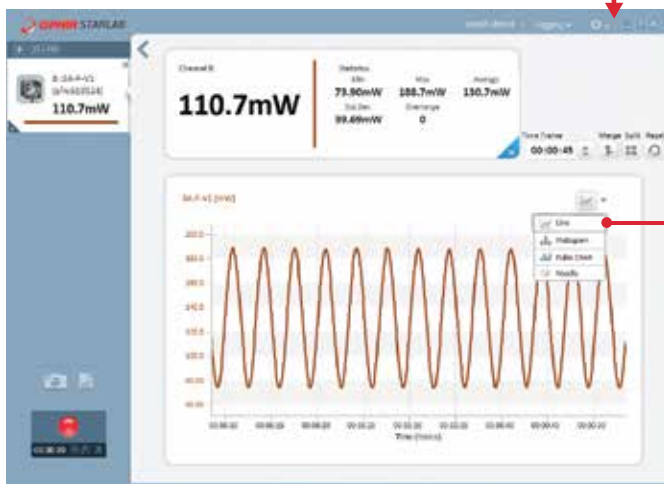

One of the above screens is maximized

You may choose to display them separately

Maximize one of the sources



Choose line graph

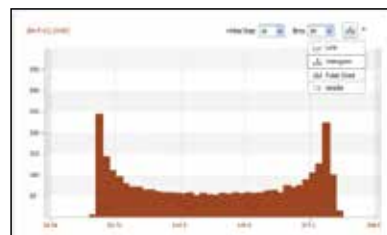

or histogram

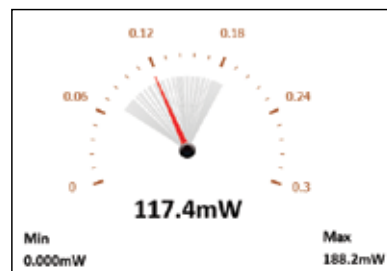

or needle display

Multiple Sensors displayed together

- Click on one of the channels
- The numerical values are from the channel chosen



Here multi line graph display has been chosen

- Settings and functions may be opened to adjust then minimized as needed
- Additional functions are available from the "Functions" tab



Here multi line histogram display has been chosen

Functions and Logging

Functions

Click on f(x) to open another trace combining measured values

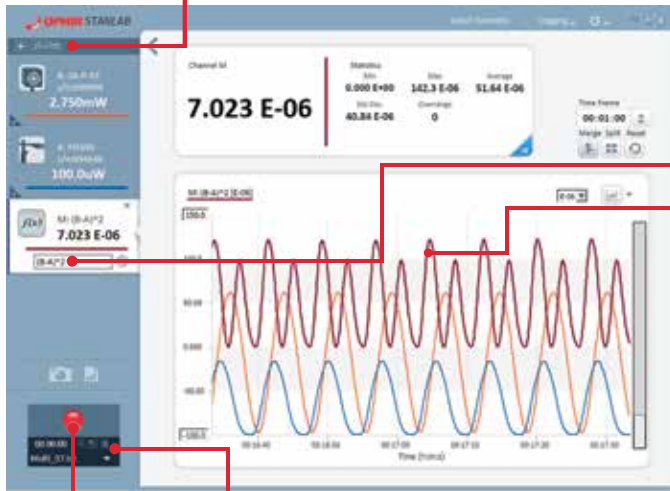

Define function combining measured values

New trace is now added per defined function

Files are stored here. They may be viewed graphically OR numerically

Logging

Click on log button and logging of values starts



```

:PC Software:StarLab version 3.00 build 19
:Logged:25/05/2014 at 09:33:22
:Channel B:vega Thermopile 3A-P-V1 (s/n:999999) VG2.31 (s/n:657028)
:Channel A:Juno Photodiode P0300 (s/n:694646) JNL.24 (s/n:606180)
:Math M:(A-B)^2
:Channel B:Statistics
:Min:3.440mW
:Max:12.22mW
:Average:7.882mW
:Std.Dev.:3.078mW
:Overrange:0
:First Pulse Arrived : 25/05/2014 at 09:33:22.562000

```

Timestamp	Channel B	F(B)	Channel A	Math M
0.000	1.762e-002	6.620e-003		
0.064	1.836e-002	7.304e-003		
0.128	1.911e-002	8.110e-003		
0.136			1.067e-002	6.554e-006
0.193	1.986e-002	8.860e-003	8.480e-003	1.444e-007
0.203			6.540e-003	9.181e-006
0.256	2.057e-002	9.570e-003		
0.269	2.123e-002	1.023e-002	4.900e-003	2.841e-005
0.321	0.354			
0.384	2.182e-002	1.082e-002	3.550e-003	5.285e-005
0.406				
0.449	2.232e-002	1.132e-002		
0.865	2.291e-002	1.191e-002		
0.870			3.400e-004	1.339e-004
0.928	2.258e-002	1.158e-002	3.600e-004	1.259e-004
0.936				
0.993	2.216e-002	1.116e-002	4.800e-004	1.141e-004
1.003				
1.056	2.164e-002	1.064e-002	7.600e-004	9.761e-005
1.070				
1.120	2.104e-002	1.004e-002	1.340e-003	7.569e-005
1.136				
1.184	2.038e-002	9.380e-003	2.370e-003	4.914e-005
1.203				
1.664	1.558e-002	4.580e-003		

BeamTrack Power/Position/Size Screens

Open Measuring type tab and choose Track

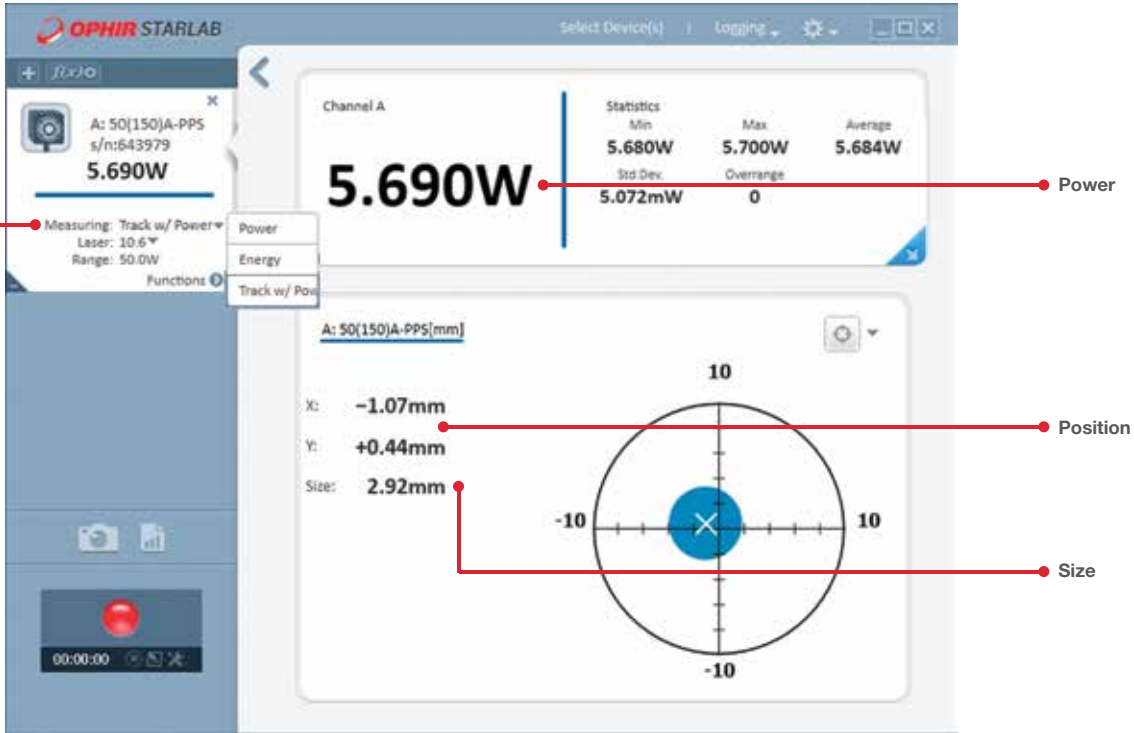

Power / Position / Size screen

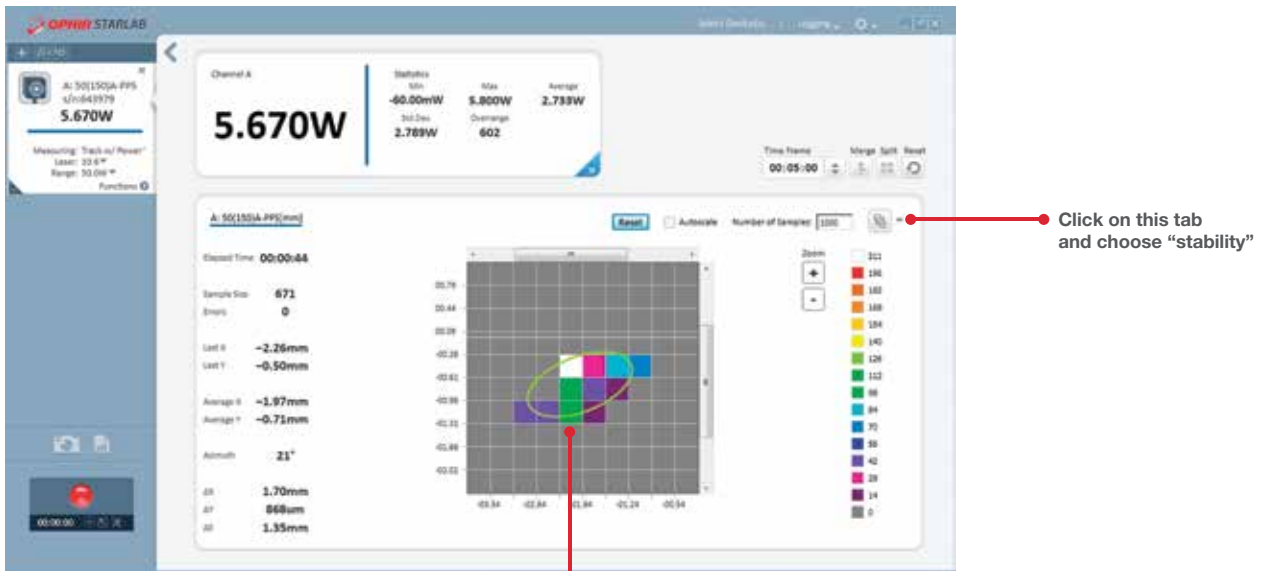

Position stability screen

Displays beam center wander weighted for dwell time at each position