

# 1.1.1 Photodiode Power Sensors

## 1.1.1.1 Standard Photodiode Sensors

### 50pW to 3W

#### Features

- Very large dynamic range
- Swivel mount for hard to measure places
- Comes with filter in / filter out options
- Patented automatic background subtraction
- Fiber optic adapters available

PD300 with filter off



PD300 with filter installed



PD300-TP Mounted on stand



Model	PD300		PD300-1W			PD300-3W			PD300-TP			
Use	General		Powers to 1W			Powers to 3W			Thin profile for tight fit			
Detector Type	silicon		silicon			silicon			silicon			
Aperture	10x10mm		10x10mm			10x10mm			10x10mm			
Calibration Uncertainty nm	±1.1% 430-1000 <sup>(b)</sup>		±1.1% 430-1000 <sup>(b)</sup>			±1.1% 430-1000 <sup>(b)</sup>			±1.1% 430-1000 <sup>(b)</sup>			
Filter Mode	Filter out	Filter in	Filter out	Filter in	Filter in	Filter out	Filter in	Filter out	Filter in	Filter out	Filter in	
Spectral Range nm	350-1100	430-1100	350-1100	430-1100	430-1100	350-1100	430-1100	350-1100	400-1100	350-1100	400-1100	
Power Range	500pW to 30mW	2μW to 300mW	500pW to 30mW	2μW to 1W	2μW to 1W	5nW to 100mW	2μW to 3W	50pW to 3mW	2μW to 1W	50pW to 3mW	2μW to 1W	
Power Scales	30mW to 30nW and dBm	300mW to 300μW and dBm	30mW to 30nW and dBm	1W to 300μW and dBm	1W to 300μW and dBm	100mW to 300nW and dBm	3W to 300μW and dBm	3mW to 3nW and dBm	1W to 300μW and dBm	3mW to 3nW and dBm	1W to 300μW and dBm	
Resolution nW	0.01	NA	0.01	NA	NA	0.1	NA	0.001	1	0.001	1	
Maximum Power vs. Wavelength	nm	mW	mW	nm	mW	mW	nm	mW	mW	nm	mW	mW
	<488	30	300	<488	30	1000	<488	100	3000	350-400	3	NA
	633	20	300	633	20	1000	633	100	3000	400-500	3	1000
	670	13	200	670	13	1000	670	100	2000	600	2.5	1000
	790	10	100	790	10	600	790	100	1200	700	2	500
	904	10	100	904	10	700	904	100	1200	800-950	1.5	300
	1064	25	250	1064	25	1000	1064	100	2200	1064	3	500
Accuracy (including errors due to temp. variations)												
% error vs Wavelength nm	±10	360-400	NA	±10	360-400	NA	±10	360-400	NA	±7	350-400	NA
	±3	400-980	±5	430-980	±3	400-950	±5	430-950	±3	400-950	±5	400-450
	±5	980-1100	±7	980-1100	±4	950-1030	±6	950-1030	±4	950-1030	±6	450-950
					±6	1030-1100	±7	1030-1100	±6	1030-1100	±7	950-1100
Damage Threshold W/cm <sup>2</sup>	10	50	10	10	10 <sup>(a)</sup>	10	30	10	30	10	50	
Max Pulse Energy μJ	3	30	3	3	200	30	400	1	100	1	100	
Noise Level for filter out pW	20	20	20	20	200	200	200	±2	±2	±2	±2	
Response Time with Meter s	0.2	0.2	0.2	0.2	0.2	0.2	0.2	0.2	0.2	0.2	0.2	
Beam Position Dependence	±2%	±2%	±2%	±2%	±2%	±2%	±3%	±2%	±2%	±2%	±2%	
Background Subtraction	95-98% of background is cancelled automatically under normal room conditions, even when changing continuously						N.A.			N.A.		
Fiber Adapters Available (see page 32)	ST, FC, SMA, SC		ST, FC, SMA, SC			ST, FC, SMA, SC			N.A.			
Compliance	CE, UKCA, China RoHS		CE, UKCA, China RoHS			CE, UKCA, China RoHS			CE, UKCA, China RoHS			
Version	V1		V1			V1			V1			
Part Number	7Z02410		7Z02411A			7Z02426			7Z02424			

Notes: (a) Maximum power density above which sensor may not read correctly. There will be no permanent damage until 50W/cm<sup>2</sup>  
 (b) For calibration uncertainty of wavelengths outside of this range see table on page 24

\* For graphs see page 30-31

\* For PD300-3W drawing see PD300-UV/PD300-IR drawing on page 26

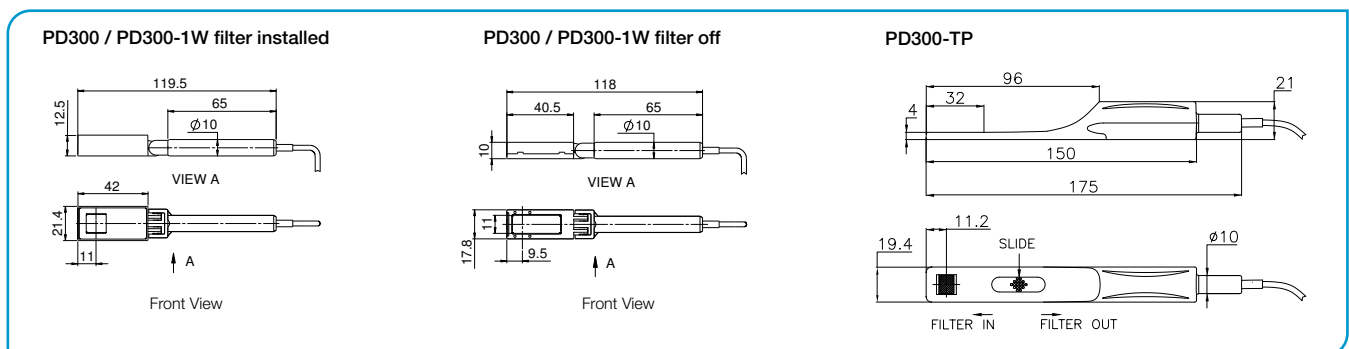

# 1.1.1.1 Standard Photodiode Sensors

## 10pW to 300mW

### Features

- Spectral range including UV and IR
- Very large dynamic range
- Swivel mount for hard to measure places
- Comes with filter in / filter out options
- Fiber optic adapters available

PD300-UV / PD300-IR with filter off



PD300-UV / PD300-IR with filter installed



PD300-IRG with fiber input



Model	PD300-UV/ PD300-UV-193			PD300-IR			PD300-IRG					
Use	Lowest powers from 200-1100nm			Low powers from 700-1800nm			Telecom wavelength fiber and free space measurements					
Detector Type	silicon			Germanium			InGaAs					
Aperture	10x10mm			Ø5mm			Ø5mm for free space beams					
Calibration Uncertainty nm	±1.1% 430-1000 <sup>(b)</sup>			±2.4% 700-1430 <sup>(b)</sup>			±2.4% 800-1430 <sup>(b)</sup>					
Filter Mode	Filter out		Filter in	Filter out		Filter in	Filter out		Filter in			
Spectral Range nm	200 - 1100		220 - 1100	700-1800		700-1800	800 - 1700		950 - 1700			
Power Range	20pW to 3mW		2µW to 300mW	5nW to 30mW		2µW to 300mW	10pW to 800µW		1µW to 200mW			
Power Scales	3mW to 3nW and dBm		300mW to 300µW and dBm	30mW to 30nW and dBm		300mW to 300µW and dBm	800 µW to 800pW and dBm		300mW to 30µW and dBm			
Resolution nW	0.001		100	0.01		NA	0.0001		1			
Maximum Power vs. Wavelength	nm	mW	mW	nm	mW	mW	nm	mW	mW			
	250 - 350	3	300	800	12	120	<1000	0.8	200			
	400	3	300	1000-1300	30	300	1100	0.8	200			
	600	3	300	1400	30	250	1200	0.8	200			
	800 - 950	2.5	150	1500	30	100	1300	0.8	200			
	1064	3	300	1600	30	100	1550	0.8	200			
				1800	30	300	>1600	0.8	200			
Accuracy (including errors due to temp. variations)												
% error vs Wavelength nm <sup>(a)</sup>	±10	200-230	±10	220-300	±5	700-800	±6	700-900	±3	1000-1650	±6	1000-1650
	±7	230-300	±4	300-420	±4	800-1700	±5	900-1700	±5	<1000 & >1650	±8	<1000 & >1650
	±3	300-420	±3	420-980	±7	1700-1800	±9	1700-1800				
	±2	420-980	±7	980-1100								
	±7	980-1100										
Damage Threshold W/cm2	10		50	10		50	5		50			
Max Pulse Energy µJ	1		50	0.75		2	1		100			
Noise Level for filter out pW	±1			200			±300W at 1550 nm and 1s average					
Response Time with Meter s	0.2			0.2			0.2					
Beam Position Dependence	±2%			±2%			±1% over 80% of aperture					
Fiber Adapters Available (see page 32)	ST, FC, SMA, SC			ST, FC, SMA, SC			FC, FC/APC, SMA					
Compliance	CE, UKCA, China RoHS			CE, UKCA, China RoHS			CE, UKCA, China RoHS					
Version							V1					
Part Number	PD300-UV: PD300-UV-193:		ZZ02413 ZZ02413A <sup>(a)</sup>	ZZ02412		ZZ02402						

Notes: (a) Same as above with additional calibration point at 193nm accuracy ±6%  
(b) For calibration uncertainty of wavelengths outside of this range see table on page 24

\* For graphs see page 30-31

PD300-UV / PD300-IR filter installed (Ø5mm for PD300-IR only)

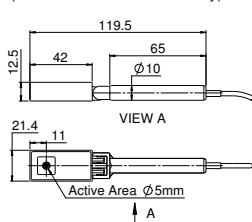

PD300-UV / PD300-IR filter off (Ø5mm for PD300-IR only)

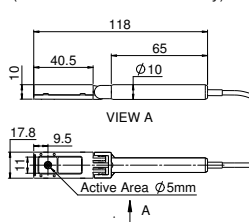

PD300-IRG

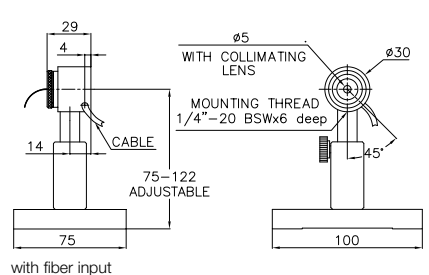

**Temperature Coefficient of Sensitivity**

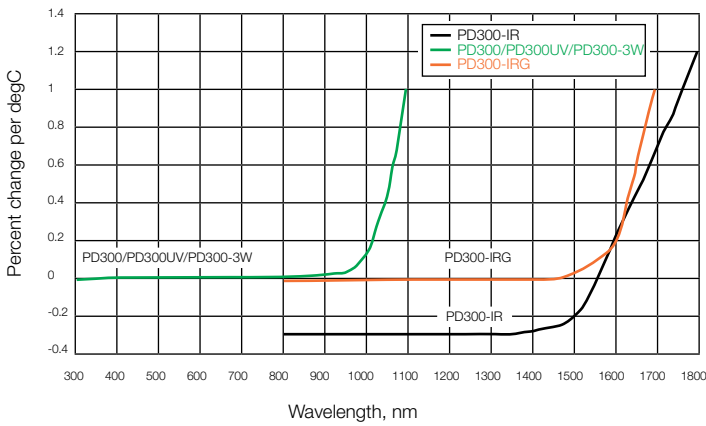

**PD300 Angle Dependence**

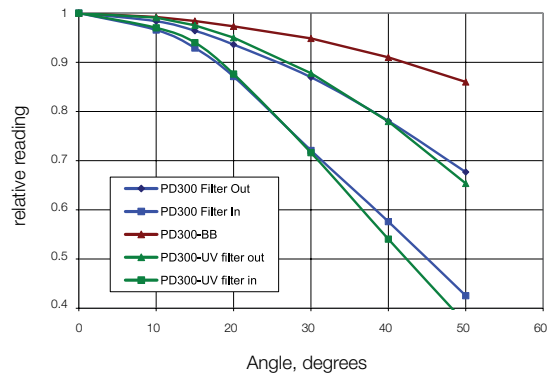

**Dependence of Sensitivity on Numerical Aperture (PD300 - IRG)**

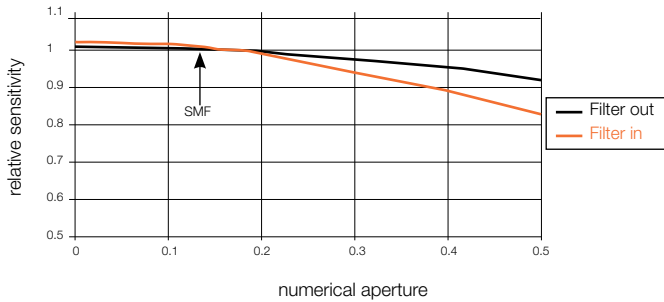

Note:

1. Graph assumes equal intensity into all angles up to maximum N.A.
2. Calibration is done with SMF, N.A. 0.13

**PD300-CIE Spectral Response vs. CIE Curve**

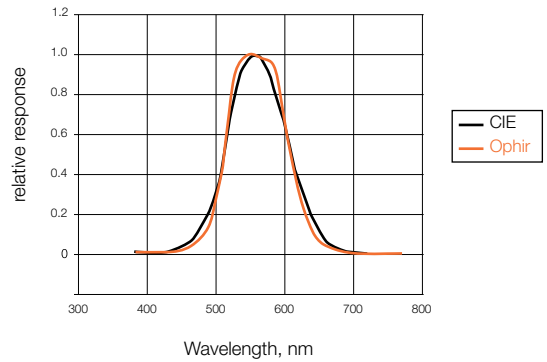

**Typical Sensitivity Curve of PD300-BB Sensors**

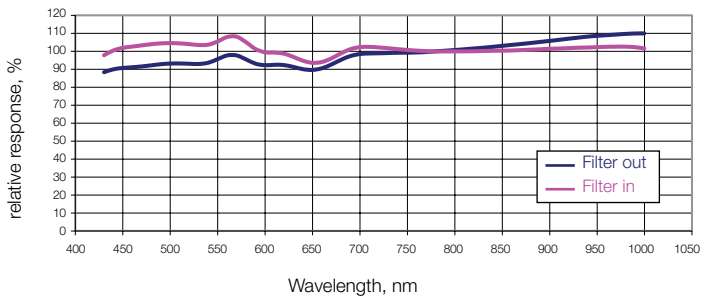

**BC20 Relative Spectral Response**

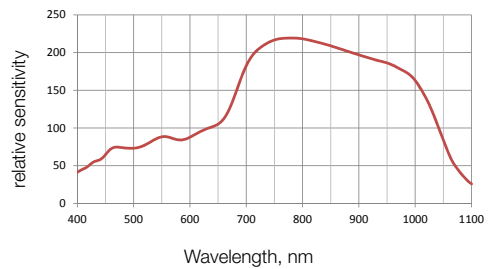

# Approximate Spectral Response

Relative to 633nm or 1550nm

