

1.1.2.9 Beam Dumps

Up to 11kW

Features

- Up to 11kW CW
- Water or Fan cooled
- High Power Density
- Ø45-65mm apertures

BDFL500A-BB-50



BDFL1500A-BB-65



BD5000W-BB-50



BD10K-W



Model	BDFL500A-BB-50	BDFL1500A-BB-65	BD5000W-BB-50	BD10K-W
Use	General purpose High power beam dump			
Absorber Type	Broadband	Broadband	Broadband	Beam Deflector + Broadband
Spectral Range μm	0.19 - 20	0.19 - 20	0.19 - 20	0.8 - 20
Typical Absorption	86% for 600 to 2500nm, 82% for 10.6 μm			
Aperture mm	Ø50mm	Ø65mm	Ø50mm	Ø45mm
Maximum Incident Power	500W	1500W	5000W	11,000W
Maximum Average Power Density	7kW/cm ²	6kW/cm ² at 1000W 1.5kW/cm ² at 1500W	6kW/cm ² at 1000W 3kW/cm ² at 5000W	See note (b) below
Maximum Energy Density J/cm ²	See note (b) below			
<100ns	0.3	0.3	0.3	
1 μs	0.4	0.4	0.4	
0.5ms	5	5	5	
2ms	10	10	10	
10ms	30	30	30	
Cooling	fan	fan	water	water
Minimum Water Flow Rate at Full Power	N/A	N/A	5 liter/min (a)	8 liter/min (a)
Accessories for High Power Sensors	See pages 97-100	See pages 97-100	See pages 97-100	See pages 97-100
Weight kg	0.9	2.4	2.8	4.5
Compliance	RoHS, China RoHS	RoHS, China RoHS	RoHS, China RoHS	RoHS, China RoHS
Version				V1
Part number	7Z17200	7Z17203	7Z17201	7Z17205

Note: (a) Water temperature range 18-30°C. Water temperature rate of change <1°C/min. Pressure drop across BD5000W-BB-50 beam dump 0.06MPa.
Pressure drop across BD10K-W beam dump 0.1MPa.

Note: (b) Max power and energy density

Beam diameter	Max power density	Max energy density	1ms pulse width	10ms pulse width
<15mm	10kW/cm ²	30J/cm ²	60J/cm ²	150J/cm ²
15 - 20mm	7kW/cm ²	20J/cm ²	40J/cm ²	100J/cm ²
20 - 40mm	5kW/cm ²	15J/cm ²	30J/cm ²	70J/cm ²
40 - 45mm	4kW/cm ²	12J/cm ²	25J/cm ²	60J/cm ²

BDFL500A-BB-50

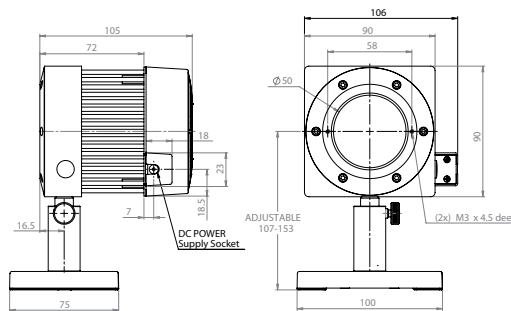

BDFL1500A-BB-65

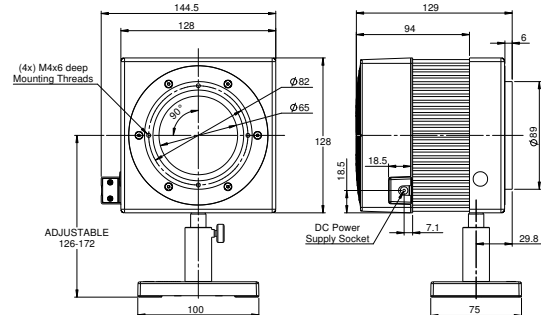

BD5000W-BB-50

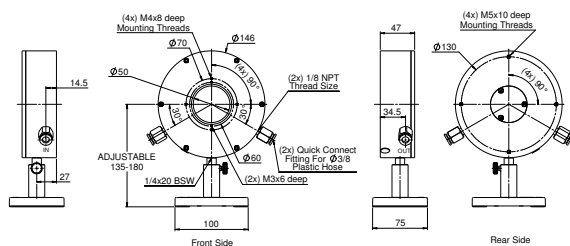

BD10K-W

